

# SILO SCD400

## CARACTÉRISTIQUES

BACS DE STOCKAGE D'UNE CAPACITE DE 413 KG (CAPACITE DU CHARRIOT NON INCLUS)

BACS DE STOCKAGE EN ACIER INOXYDABLE AISI 304

CUVE INTERIEURE EN POLYETHYLENE SANITAIRE DE GRANDE DURETE, RESISTANT AUX COUPS ET AUX RAYURES

EASY CLEANING DESIGN®: UNE SEULE PIÈCE SANS SOUDURE AVEC DES COINS ARRONDIS, POUR ÉVITER DES COUPS POSSIBLES ET POUR FACILITER DU NETTOYAGE

SYSTEME DE DRAINAGE PERMETTANT DE COLLECTER ET DE CONDUIRE L'EAU VERS LA VIDANGE EN CONSERVANT LE BAC PROPRE ET SEC

GRANDE CAPACITE EASY CART® : JUSQU'À 112 KG DE GLACE (70 KG AVEC SCEAUX), ERGONOMIQUE, FACILE A DEPLACER AVEC PEU D'EFFORT

EASY CART® DISPOSE D'UN SYSTEME DE FREINAGE ET DE VIDANGE

EASY CART® EST EN POLYÉTHYLÈNE SANITAIRE, À SURFACE LISSE POUR FACILITER LE NETTOYAGE. IL COMPREND UNE COUVERTURE POUR EMPÊCHER LA SALETE DE CONTAMINER LA GLACE.

LES SCEAUX POUR DISTRIBUER LA GLACE RAPIDEMENT ET SANS EFFORT PEUVENT ETRE INCLUS



## MACHINES RECOMMANDÉES

### MDP150/MR400/MP



2 MDP150 MR400



2 MP145

### SPIKA

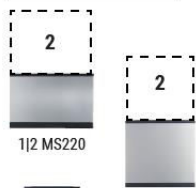

1/2 MS220

1/2 MS410

MS300 SLIM

### ICE QUEEN



1/2 IQ200

1/2 IQ400

1/2 IQ550

IQ550 SPLIT

IQ850 CO2 SPLIT

IQ1100

IQ1100 SPLIT

### SCALA



SCALA 400  
SCALA 400 SPLIT

SCALA 600  
SCALA 600 SPLIT

SCALA  
1000/1500/2000/3000  
SPLIT

## ACCESSOIRES



TUYAU  
D'EVACUATION



GRANDE PELLE



PELLE A GLACE A LONG  
MANCHE



SUPPORT POUR  
LA PELLE A  
GLACE



SCEAUX

# SCHÉMA TECHNIQUE

VUE DE DROITE

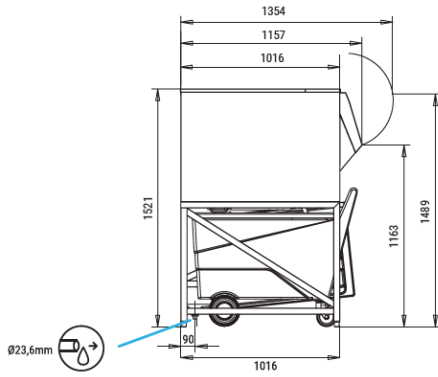

VUE FRONTALE

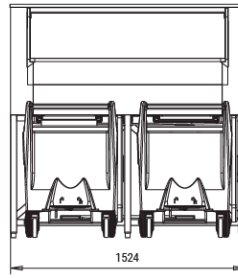



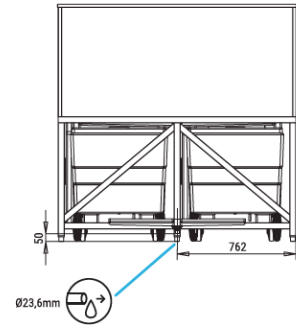



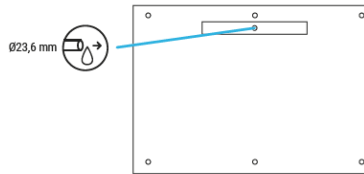

VUE ARRIERE



VUE SUPERIEURE



\*Toutes les côtes sont en mm.

	 (Kg)	 (Kg)	 (Kg)	 (mm)	 (Kg)	 (mm)	 (Kg)	 (m³)
BIN SCD400	413	330	637	Width 1.524 Depth 1.016* Height 1.520	140	Width 1.630 Depth 1.240 Height 1.660	235	3,36

\*Sans porte