

# SILO SCD600

## CARACTÉRISTIQUES

BACS DE STOCKAGE D'UNE CAPACITE DE 617 KG (CAPACITE DU CHARRIOT NON INCLUS)

BACS DE STOCKAGE EN ACIER INOXYDABLE AISI 304

CUVE INTERIEURE EN POLYETHYLENE SANITAIRE DE GRANDE DURETE, RESISTANT AUX COUPS ET AUX RAYURES

EASY CLEANING DESIGN®: UNE SEULE PIÈCE SANS SOUDURE AVEC DES COINS ARRONDIS, POUR ÉVITER DES COUPS POSSIBLES ET POUR FACILITER DU NETTOYAGE

SYSTEME DE DRAINAGE PERMETTANT DE COLLECTER ET DE CONDUIRE L'EAU VERS LA VIDANGE EN CONSERVANT LE BAC PROPRE ET SEC

GRANDE CAPACITE EASY CART® : JUSQU'À 112 KG DE GLACE (70 KG AVEC SCEAUX), ERGONOMIQUE, FACILE À DÉPLACER AVEC PEU D'EFFORT

EASY CART® DISPOSE D'UN SYSTEME DE FREINAGE ET DE VIDANGE

EASY CART® EST EN POLYÉTHYLÈNE SANITAIRE, À SURFACE LISSE POUR FACILITER LE NETTOYAGE. IL COMPREND UNE COUVERTURE POUR EMPÊCHER LA SALETE DE CONTAMINER LA GLACE.

LES SCEAUX POUR DISTRIBUER LA GLACE RAPIDEMENT ET SANS EFFORT PEUVENT ÊTRE INCLUS



## MACHINES RECOMMANDÉES

### MDP150/MR400/MP



2 MDP150



MR400

### SPIKA



2 MS220



1/2 MS410

### ICE QUEEN



1/2 IQ400



1/2 IQ550 SPLIT



IQ1100



1/2 IQ550



IQ850 CO2SPLIT



IQ1100 SPLIT

### SCALA



SCALA 400  
SCALA 400 SPLIT



SCALA 600  
SCALA 600 SPLIT



SCALA  
1000/1500/2000/3000  
SPLIT

## ACCESSOIRES



TUYAU  
D'ÉVACUATION



GRANDE PELLE



PELLE À GLACE À LONG  
MANCHE



SUPPORT POUR  
LA PELLE À  
GLACE







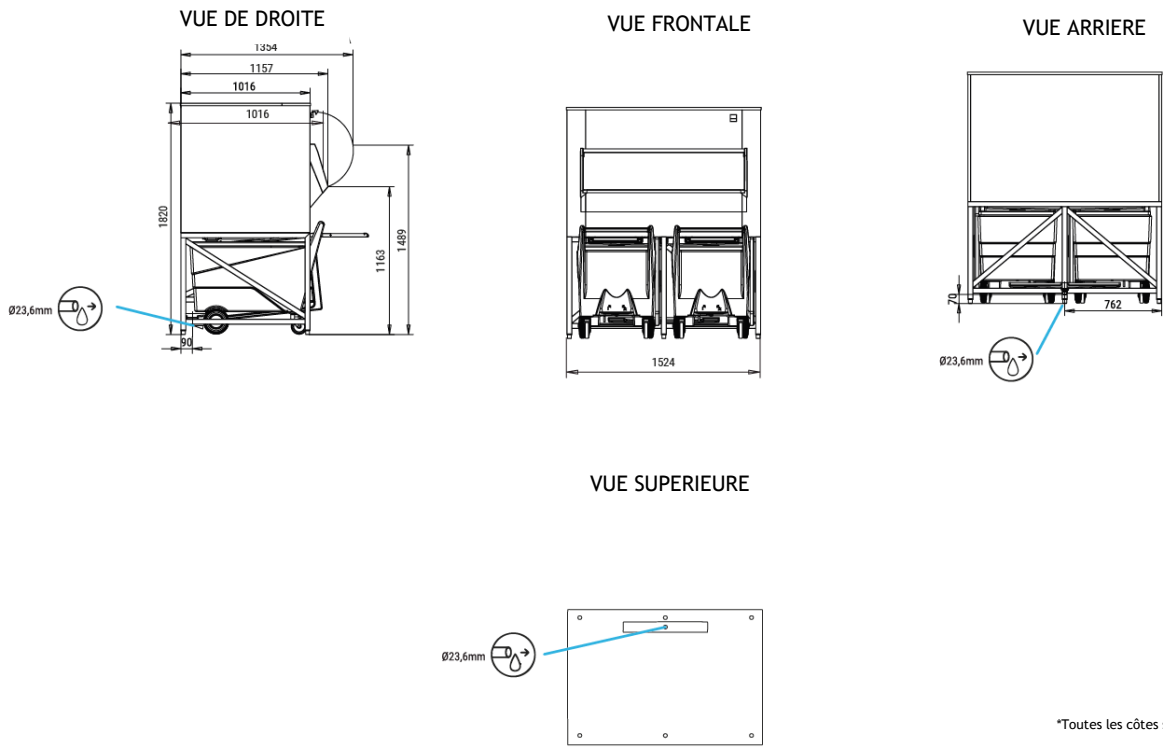



SCEAUX

# SCHÉMA TECHNIQUE



\*Toutes les côtes sont en mm.

	 (Kg)	 (Kg)	 (Kg)	 (mm)	 (Kg)	 (mm)	 (Kg)	 (m³)
SILO SCD600	617	494	841	Width 1.524 Depth 1.016* Height 1.820	160	Width 1.630 Depth 1.240 Height 1.980	255	4

\*Sans porte